



# The Flygt Bibo dewatering pumps

Tough, portable and reliable submersibles, 50 Hz



# The Flygt Bibo submersible range. Saving time. Time after time.

Flygt Bibo pumps save you time, every time. Portable, robust and reliable, they'll take on the toughest dewatering tasks anywhere you need them. Operating submerged they don't need complicated installation or dedicated superstructures: just lower the pump into a pit and switch on the power.

It's that quick and easy. And with very little maintenance required, time is not the only thing that a Flygt Bibo can save.

## More than 50 years of continuous development

The first Flygt Bibo pump was launched in 1947. The unique design made it the world's first submersible dewatering pump – a revolutionary concept that meant quieter operation, no dry-mounting superstructure or special housing and no long mechanical shafts.

And the design has been continuously improved and refined ever since, with new and specialist models being introduced to tackle the toughest of tasks in the most hostile environments.

**Bibo is Latin for  
"I drink"**

**Flygt Bibo pumps are ideal** for applications in which the water or liquid contains concentrations of abrasives such as:

- clay
- sand
- grit and gravel
- drilling fines

## A casing for all conditions.

Flygt Bibo pumps are available in a range of casing materials to suit different applications:

- lightweight aluminium
- hard-wearing cast iron
- stainless steel

**Flygt Bibo pumps are tested and approved** in accordance with international standards IEC 34-1 and CSA. Some models are also used in areas where explosion proof equipment is required.

A wide range of Flygt Bibo pumps have been designed for use in special conditions, such as:

- warm liquid
- sea water
- corrosive liquid



# More people trust Flygt Bibo than any other brand

Today, there are more Flygt Bibo dewatering pumps in operation around the world than any other competitive brand. In fact, it's not unusual for an original Flygt Bibo to turn up on a site, still working after 40 years or more of excellent service.

## Construction

The Flygt Bibo range is the ideal choice for all construction site dewatering tasks. Whether it is active dewatering of ground water, with slim line pumps, passive dewatering of ground water, or the removal of seawater in a harbour for bridge construction. And because they are portable, the pumps can simply be moved to another part of the site, when they have completed a task.

## Mining & quarrying

With over 50 years of experience in some of the most demanding mines and quarries in the world, the Flygt Bibo range of pumps have been designed to handle the toughest conditions. And many models are available in explosion proof versions, which means they can be used just about anywhere in a mine that requires dewatering.

## Tunnelling

Whether you are tunnelling under a lake, seabed, mountain range, or city, you need to know that the pumps removing the water are reliable. That's why Flygt Bibo pumps are in operation in tunnelling projects the world over. Manufactured strictly in accordance with international standards, a Flygt Bibo pump won't let you down, wherever you are.

## Other industries

Flygt Bibo pumps can also be found performing general dewatering duties in many other industries. These include fish farms, pulp and paper mills, power stations, shipyards and oil and gas facilities. Often performing temporary or emergency dewatering tasks, they will always meet your demands.



# Building on the Flygt Bibo reputation

## The toughest impellers in the business

All Flygt Bibo impellers are manufactured and designed by ITT Flygt. The high-chromium content and special hardening (to HRC 60) ensure outstanding wear resistance, prolonged operation at rated performance and reduced maintenance costs.

Whether you choose an open or semi-open multi-vane impeller with adjustable diffuser and strainer for abrasive media and demanding operating conditions, or a stainless steel impeller for corrosive environments, ITT Flygt-manufactured designs are among the most reliable on the market.

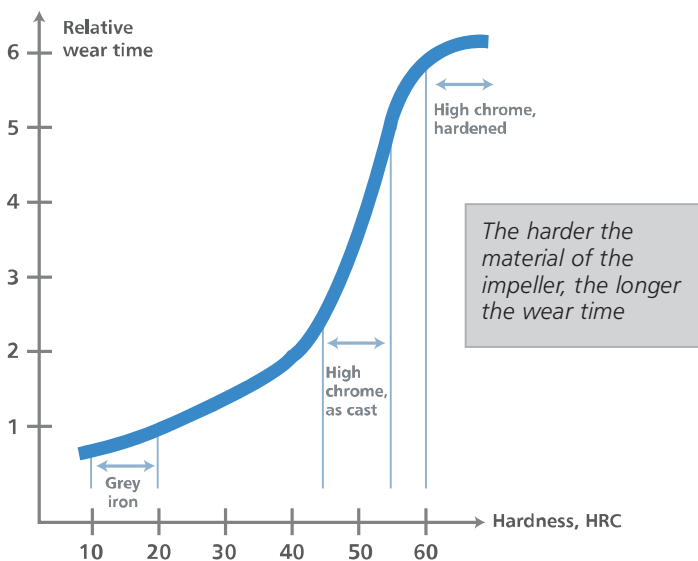

## Cables

The full range of submersible cables includes the Flygt-developed SubCab<sup>®</sup> heavy-duty cable, screened cables and special cables for warm liquid, high voltage and chemical environments.

## Discharge options

The discharges are available in a variety of configurations including hose connections and threaded for pipe or quick release couplings.

## Internal wear-part protection

All major components subjected to wear are coated with nitrile rubber, or polyurethane for extreme abrasion protection.

## Triple-function oil housing

Seals are lubricated in a dedicated oil housing, which also serves to diffuse heat from the motor and the bearings, and provides a barrier between the pumped liquid and the motor.

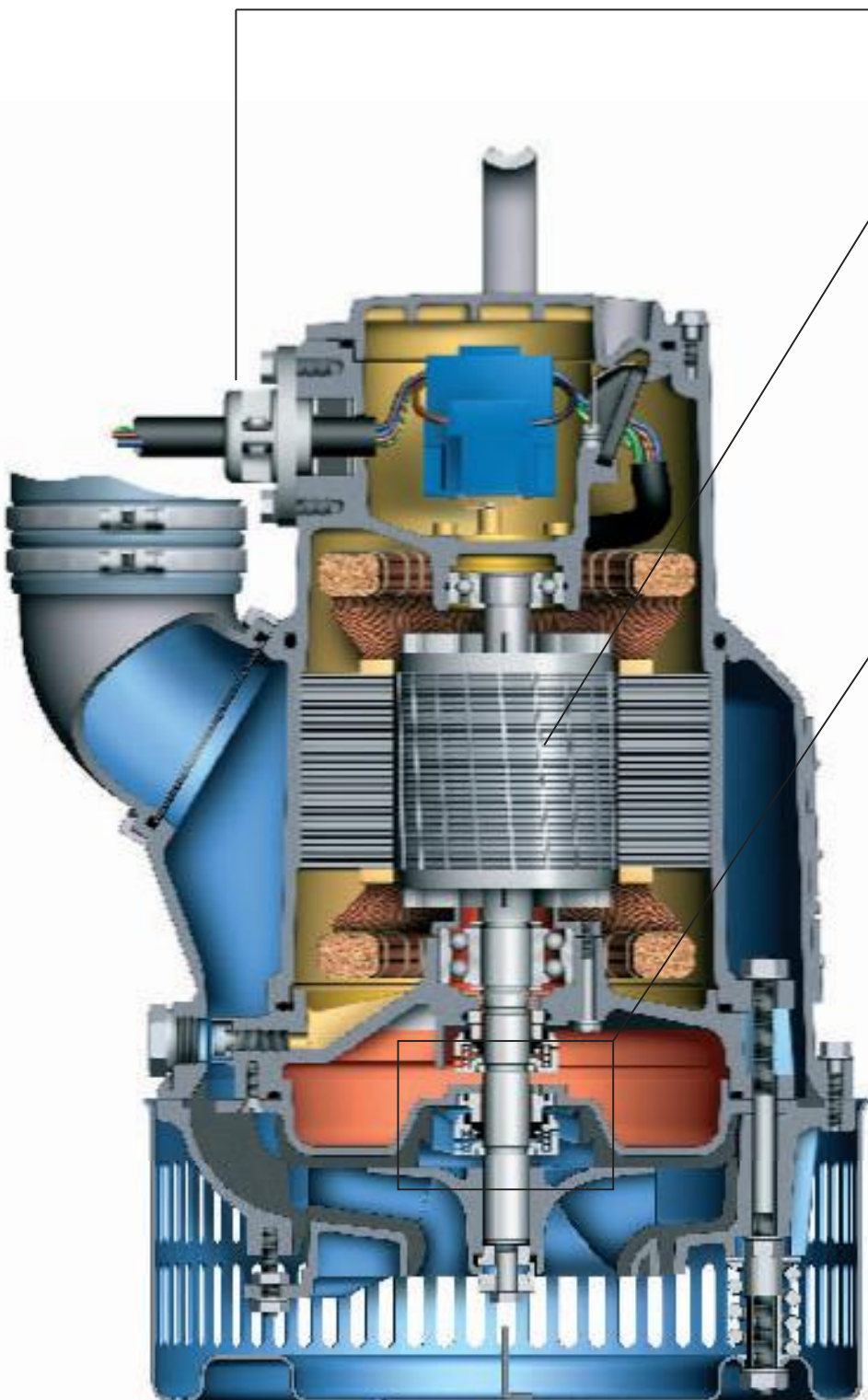

**Secure cable entrance**

Cables are protected through a special entrance designed to incorporate both a seal and a strain relief function.

**High performance motors**

ITT Flygt has designed its high performance induction motors specifically for submersible use.

Insulated according to Class F or H, pumps can be left to dry run, without damage being caused to the motor.

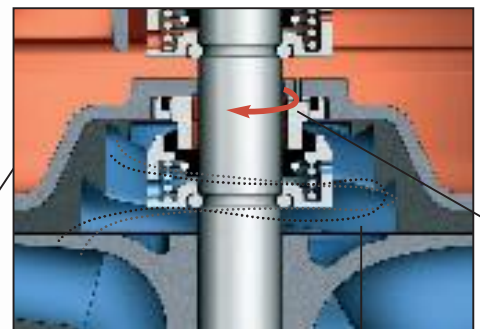

**Spin-Out™ seal protection**

Unique to ITT Flygt, this patented design protects the outer seal and extends service life by expelling abrasive particles from the seal chamber.

**Double mechanical shaft seals**

Two sets of ITT Flygt-designed mechanical shaft seals, made of WCCR corrosion resistant tungsten carbide, provide the Bibo range with double security against liquid penetration.



# The standard range – aluminium

The widest range of Flygt Bibo pumps, these hard wearing, lightweight pumps are found in operation in all types of dewatering applications.

The following pages are our standard version pumps. For more information, please contact your local ITT Flygt representative.

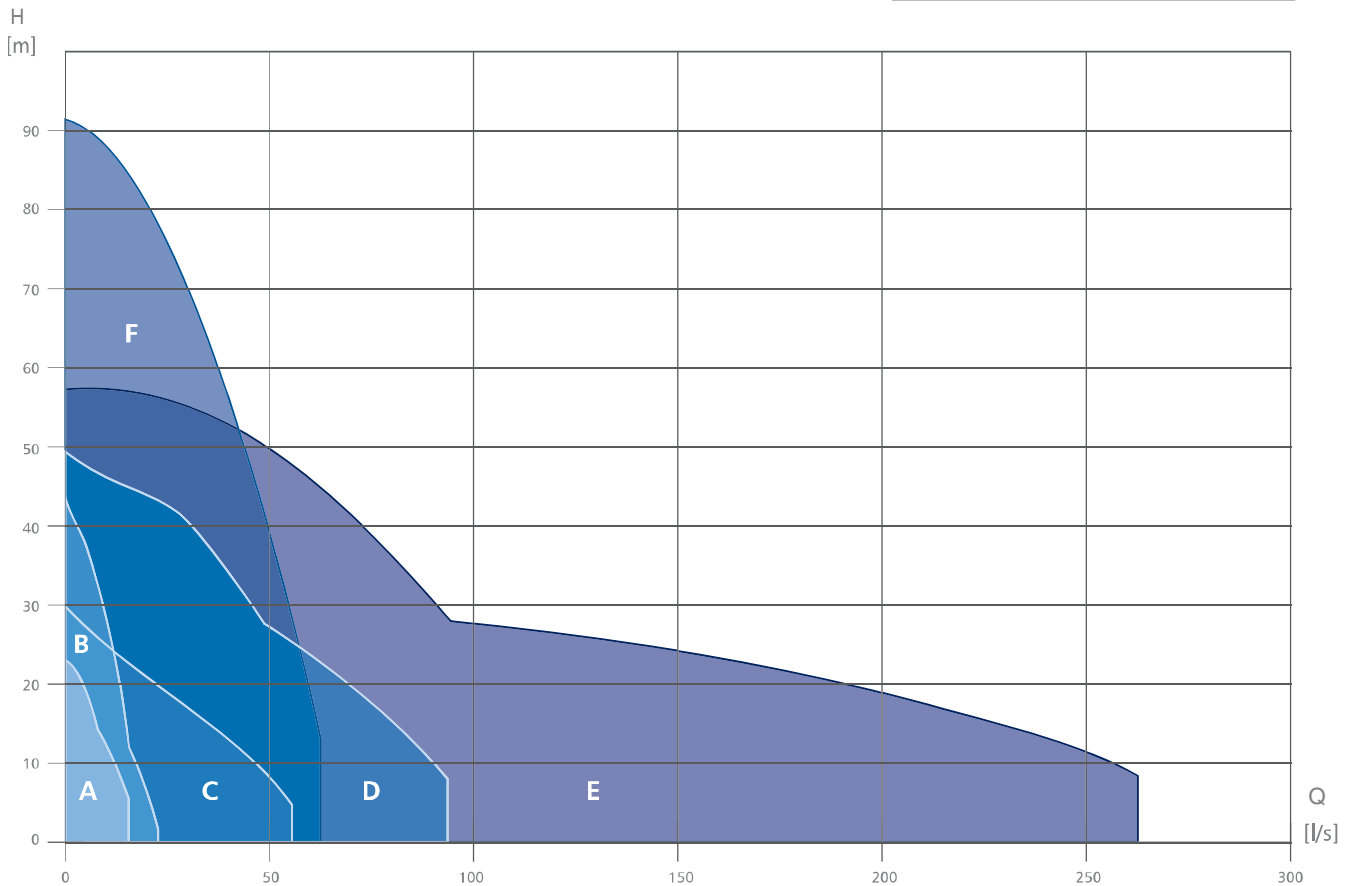

**2052**  
Aluminium



**2066**  
Aluminium



**2075**  
Aluminium



**2102**  
Aluminium

Curve	A:1	A:1	A:2	A:3	A:4	B:1	B:2	F:1	C:1	B:3	C:2	B:4
Rated power, kW	1.1	1	1.5	2.2	2.2	3.7	3.7	5.5	3.7	3.7	5.2	5.2
Curve no, type	231 MT	231 MT	234 HT	231 MT	233 HT	231 MT	233 HT	271 ST	242 MT	234 HT	231 MT	233 HT
Voltage, V/phase	230, 1~	400, 3~	230, 1~	400, 3~	400, 3~	400, 3~	400, 3~	400, 3~	400, 3~	400, 3~	400, 3~	400, 3~
Rated current, A	6.5	2.2	8.3	4.5	4.5	7.1	7.1	11	7.4	7.4	10	10
Weight, kg	18	18	30	30	30	40	40	64	50	48	50	48
Max height, mm	530	530	520	520	520	565	565	575	655	655	655	655
Max width, mm	200	200	375	375	375	445	415	405	430	390	430	390
Discharge DN, mm	50 (2")	50 (2")	75 (3")	75 (3")	75 (3")	100 (4")	75 (3")	50 (2")	100 (4")	75 (3")	100 (4")	75 (3")
Strainer hole, mm	5x18	5x18	7x21	7x21	7x21	8x8	8x8	6x6	7x40	7x40	7x40	7x40
Generator size, kVA	3	3	5	8	8	12	12	18	12	12	16	16
* warm liquid	*	*		*	*	*	*	*	*	*	*	*

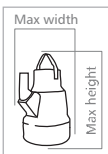

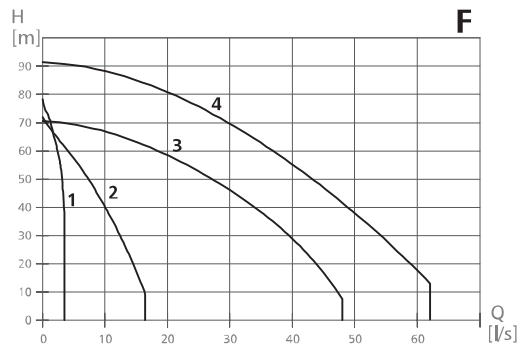
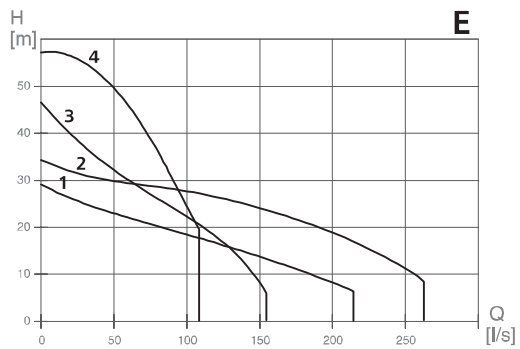
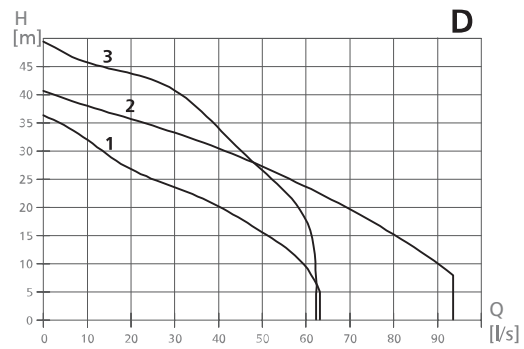
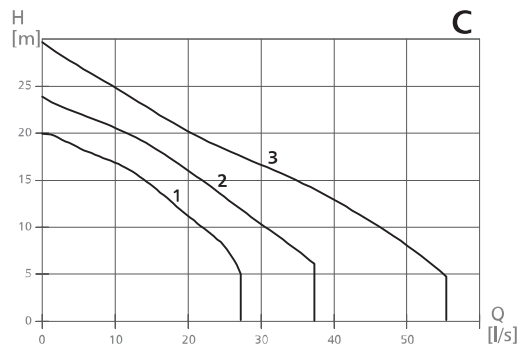
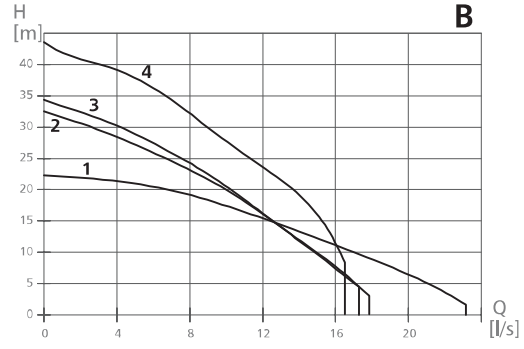
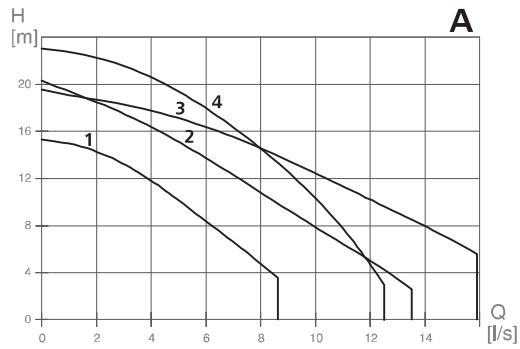

2125 Aluminium



2140 Aluminium



2151 Aluminium



2201 Aluminium



2250 Aluminium

Curve	C:3	F:2	D:1	D:2	D:3	F:3	E:1	E:3	F:4	E:2	E:4
Rated power, kW	8	8	12	20	20	20	30	37	37	54	54
Curve no, type	231 MT	233 HT	231 MT	231 LT	241 MT	233 HT	411 LT	231 MT	243 HT	431 MT	433 HT
Voltage, V/phase	400, 3~	400, 3~	400, 3~	400, 3~	400, 3~	400, 3~	400, 3~	400, 3~	400, 3~	400, 3~	400, 3~
Rated current, A	15	15	23	35	35	35	57	65	65	101	101
Weight, kg	82	89	82	165	165	165	280	280	240	540	540
Max height, mm	850	850	845	930	930	930	1 302	1 302	1 050	1 144	1 144
Max width, mm	535	465	535	640	640	590	500	500	430	915	830
Discharge DN, mm	150 (6")	75 (3")	150 (6")	150 (6")	150 (6")	100 (4")	200 (8")	200 (8")	100 (4")	250 (10")	150 (6")
Strainer hole, mm	6x50	6x50	6x50	10x42	10x42	10x42	15x45	15x45	10x10	15x45	15x45
Generator size, kVA	25	25	40	60	60	60	90	120	120	170	170
* warm liquid											

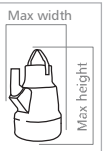

# Cast iron

Cast iron Flygt Bibo pumps are designed for use in corrosive or abrasive liquids. All the cast iron pumps are available as explosion proof version.

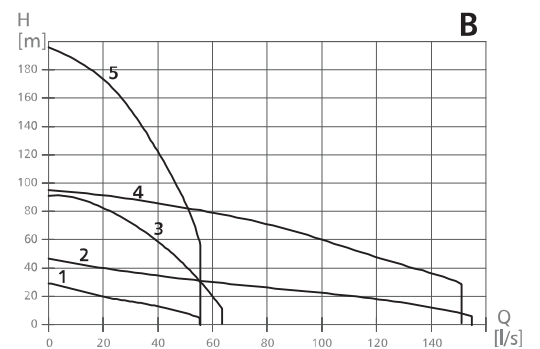
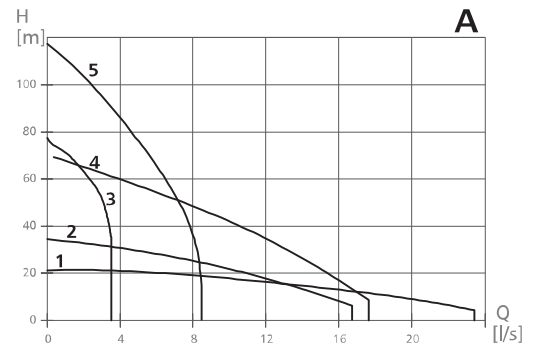
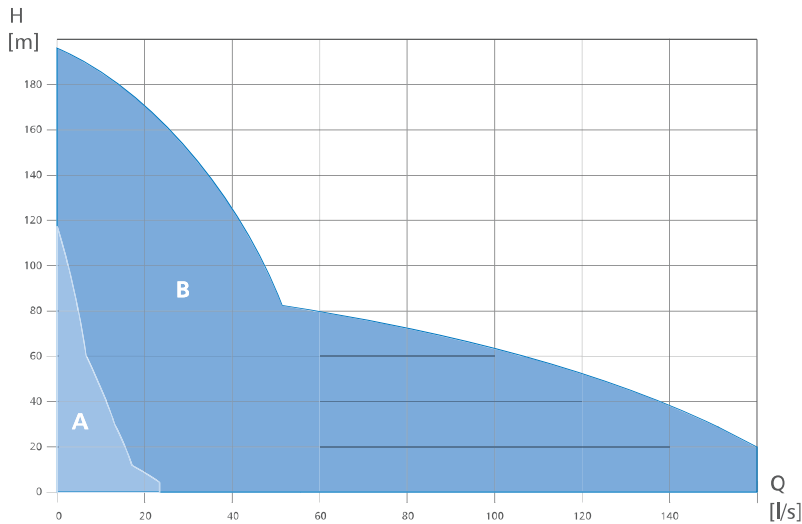

2075  
Cast iron



2125  
Cast iron



2135  
Cast iron



2201  
Cast iron



2400  
Cast iron

Curve	A:1	A:2	A:3	B:1	A:4	A:5	B:2	B:3	B:4	B:5
Rated power, kW	3.7	3.7	5.5	8	8	13.5	37	37	90	90
Curve no, type	231 MT	233 HT	271 ST	231 MT	233 HT	231 HT	231 MT	233 HT	231 MT	243 HT
Voltage, V/phase	400, 3~	400, 3~	400, 3~	400, 3~	400, 3~	400, 3~	400, 3~	400, 3~	400, 3~	400, 3~
Rated current, A	7.1	7.1	11	15	15	24	65	65	149	149
Weight, kg	73	73	90	150	165	250	445	350	900	985
Max height, mm	565	565	575	830	830	940	1 140	1 050	1 180	1 245
Max width, mm	445	415	405	485	465	362	500	435	770	770
Discharge DN, mm	100 (4")	75 (3")	100 (4")	100 (4")	75 (3")	50 (2")	200 (8")	100 (4")	150 (6")	100 (4")
Strainer hole, mm	8x8	8x8	8x50	6x50	6x50	6x6	15x45	10x10	10x10	10x10
Generator size, kVA	12	12	18	15	15	45	120	120	270	270
* warm liquid	*	*	*				*	*		

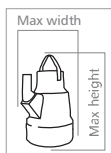



# Slim

These pumps are usually used in active dewatering. Special slim design means they fit easily into pipes or other confined spaces.

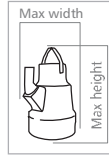
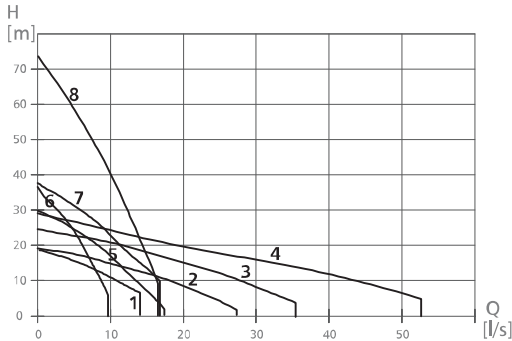

**2071 Slim Aluminium**



**2102 Slim Aluminium**



**2125 Slim Aluminium**

Curve	1	6	2	5	3	7	4	8
Rated power, kW	3	3	3.7	3.7	5.2	5.2	8	8
Curve no, type	211 LT 231 MT		242 MT 234 HT	231 MT	233 HT		231 MT	233 HT
Voltage, V/phase	400, 3~	400, 3~	400, 3~	400, 3~	400, 3~	400, 3~	400, 3~	400, 3~
Rated current, A	6.3	6.3	7.4	7.4	10	10	15	15
Weight, kg	28	28	56	56	56	56	90	93
Max height, mm	705	705	741	741	741	741	927	927
Max width, mm	185	185	293	293	293	293	360	360
Discharge DN, mm	75 (3")	75 (3")	100 (4")	75 (3")	100 (4")	75 (3")	100 (4")	100 (4")
Strainer hole, mm	8x50	8x50	Ø8	Ø8	Ø8	Ø8	6x50	6x50
Generator size, kVA	10	10	12	12	16	16	25	25
* warm liquid	*	*						

# Sludge

Flygt Bibo sludge pumps are ideal for pumping liquid containing large particles.

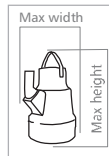
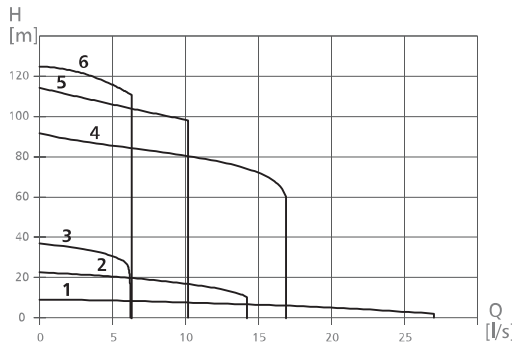

**3080 Sludge Aluminium/Cast iron**



**2201 Sludge Cast iron**

Curve	1	2	3	6	5	4
Rated power, kW	4	5.5	5.5	37	37	37
Curve no, type	431 MT 234 HT	263 ST		275 ST	276 ST	277 ST
Voltage, V/phase	400, 3~	400, 3~	400, 3~	400, 3~	400, 3~	400, 3~
Rated current, A	8.4	12	12	65	65	65
Weight, kg	62/99	62/99	62/99	415	415	415
Max height, mm	702	702	702	1 200	1 200	1 200
Max width, mm	475	475	475	495	495	495
Discharge DN, mm	100 (4")	75 (3")	50 (2")	50 (2")	50 (2")	50 (2")
Throughlet, mm	80	46	32	30	30	30
Generator size, kVA	12	18	18	120	120	120
* warm liquid						

# Stainless steel

Another option for corrosive or abrasive liquids, Flygt stainless steel Bibo pumps can also handle warm liquid pumping tasks.

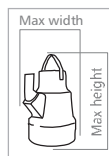
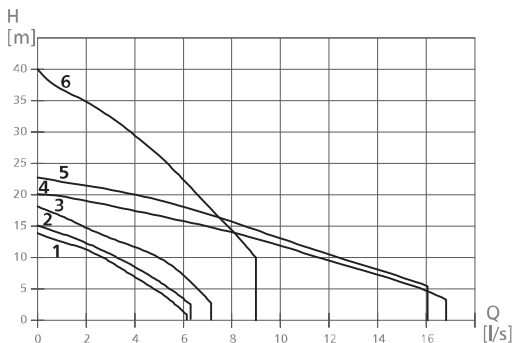

**2060 Stainless steel**



**3041 Stainless steel**



**3060 Stainless steel**

Curve	4	1	2	3	5	6
Rated power, kW	2.2	1	1.2	1.2	2.4	2.4
Curve no, type	231 MT	251 HT	251 HT	250 HT	221 MT	250 HT
Voltage, V/phase	400, 3~	230, 1~	400, 3~	400, 3~	400, 3~	400, 3~
Rated current, A	4.5	5.9	2.5	2.5	4.9	4.9
Weight, kg	32	23	23	23	40	43
Max height, mm	560	470	470	470	598	620
Max width, mm	270	240	240	240	416	424
Discharge DN, mm	65 (2.5")	50 (2")	50 (2")	50 (2")	65 (2.5")	50 (2")
Strainer hole, mm	Ø12	10.5X20	10.5X20	10.5X20	15x15	Ø5
Generator size, kVA	8	3	4	4	8	8
* warm liquid		*	*	*		

# Optimising performance

## Enhanced reliability

The versatility and reliability of the Flygt Bibo range is further enhanced through a range of options and accessories designed to simplify installation and operation.



### Pump flotation modules

Available in four different sizes, Flygt pump flotation modules are made in lightweight prefabricated polyethylene. They are a cost effective alternative to traditional steel pontoons.



### Zinc anodes

Easy to mount, for increased corrosion protection.



### Tandem connection

Several pumps can be connected in series for extra high head.



### Hoses

Rubber and PVC hoses – available for standard, high head and heavy duty applications.



### Level regulators

The level regulator switch, complete with automatic control system, provides a simple and effective method of level control.



### Discharge accessories

A range of discharge accessories can be used to connect the hose to the discharge outlet, including quick release and threaded couplings, or hose clamps.

### Starters

Flygt offers a wide range of starters designed to suit customer needs.

### FPC 100

This easy to install, automatic controller, operates without external floats or sensors. It calculates the optimal pumping cycle, resulting in less wear on parts and reduced energy consumption; considerably extending a pump's life expectancy.

