

CP 3127 LT 3~ 410 Technische specificaties

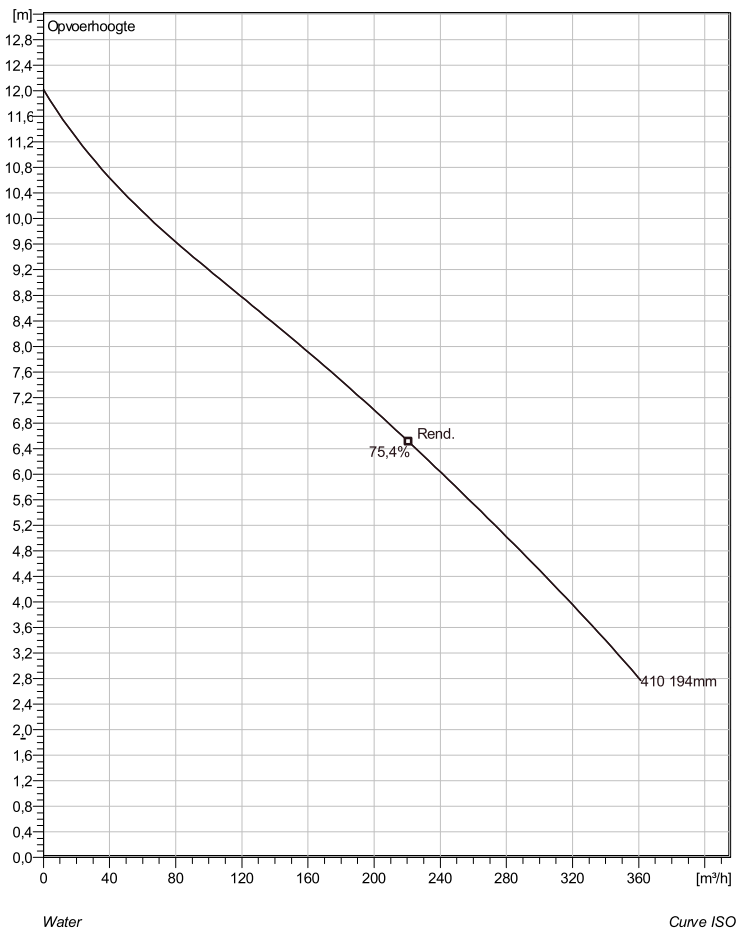

Soort installatie: Semi Permanent, Nat

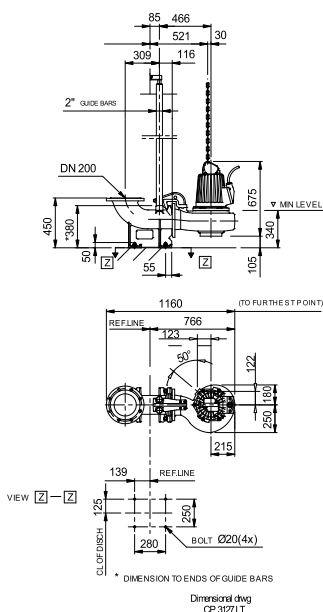

Note: Picture might not correspond to the current configuration.

General

Dompelbare pompen voorzien van één of meerkanaalwaaier met grote doorlaat. Geschikt voor afvalwater met grotere delen zoals rioolwater, regenwater en industrieel afvalwater. Materiaal gietijzer.

Impeller

Impeller material	Grey cast iron
Persaansluiting	150 mm
Diameter aanzuigzijde	150 mm
Impeller diameter	194 mm
Aantal bladen	2
Throughlet diameter	76 mm

Motor

Motor #	C3127.182 21-12-4AL-W 5.9KW standaard
Stator variant	28
Frequentie	50 Hz
Nominale spanning	190 V
Aantal polen	4
Fasen	3~
Nominaal vermogen	5,9 kW
Toegekende stroom	26 A
Aanloopstroom	171 A
Nominaal toerental	1455 rpm
Vermogensfactor	
1/1 Load	0,83
3/4 Load	0,78
1/2 Load	0,67
Motor efficiency	
1/1 Load	84,6 %
3/4 Load	84,6 %
1/2 Load	82,4 %

Project	Project ID	Created by	Created on 9/28/2018	Last update
---------	------------	------------	-------------------------	-------------

CP 3127 LT 3~ 410

Karakteristiek

Pomp

Persaansluiting	150 mm
Diameter aanzuigzijde	150 mm
Impeller diameter	194 mm
Aantal bladen	2
Throughlet diameter	76 mm

Motor

Motor #	C3127.182 21-12-4AL-W 5.9KW
Stator variant	28
Frequentie	50 Hz
Nominale spanning	190 V
Aantal polen	4
Fasen	3~
Nominaal vermogen	5,9 kW
Toegekende stroom	26 A
Aanloopstroom	171 A
Nominaal toerental	1455 rpm

Vermogensfactor	
1/1 Load	0,83
3/4 Load	0,78
1/2 Load	0,67
Motor efficiency	
1/1 Load	84,6 %
3/4 Load	84,6 %
1/2 Load	82,4 %

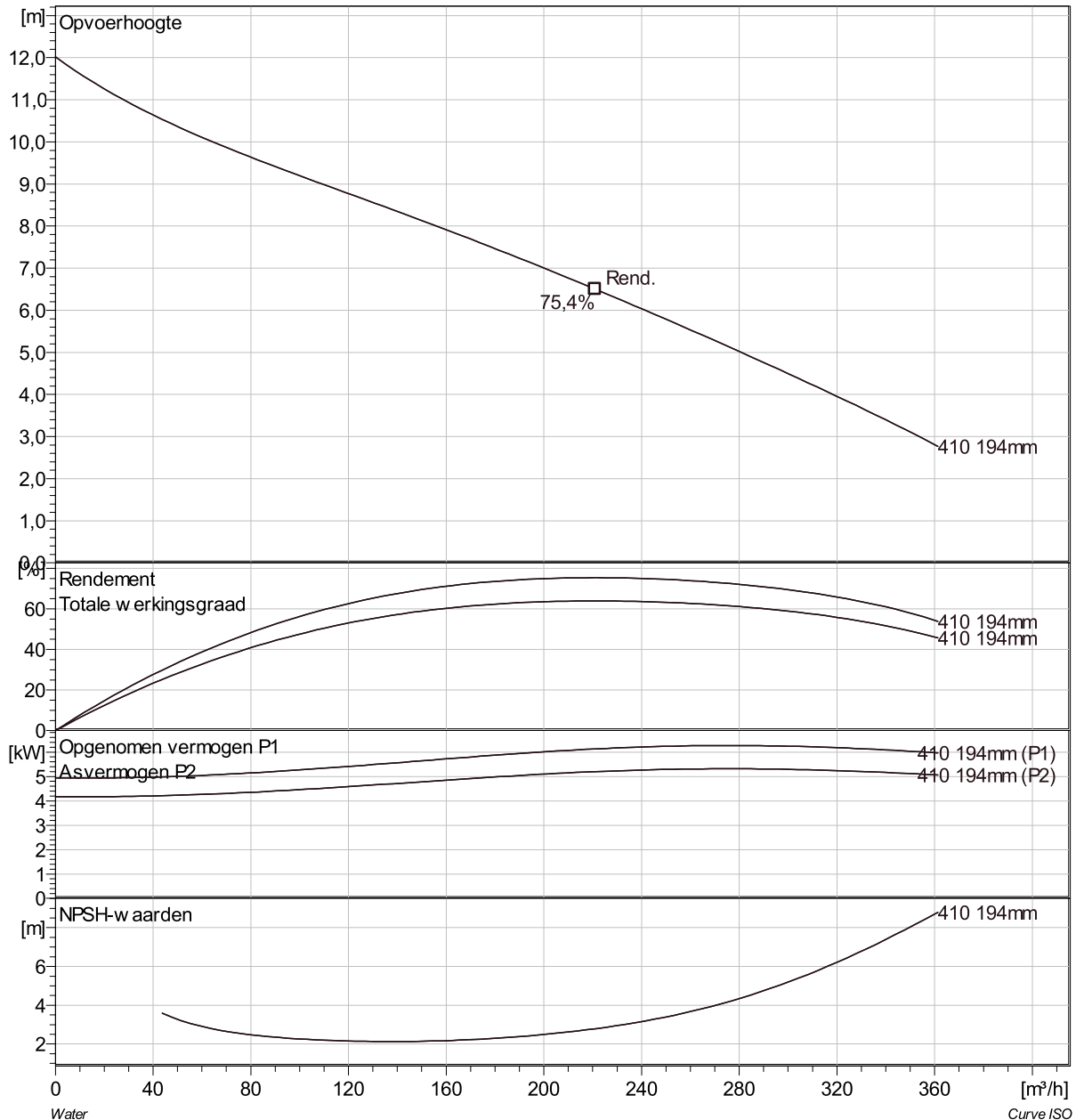

Project	Project ID	Created by	Created on 9/28/2018	Last update
---------	------------	------------	-------------------------	-------------

CP 3127 LT 3~ 410 VFD Analysis

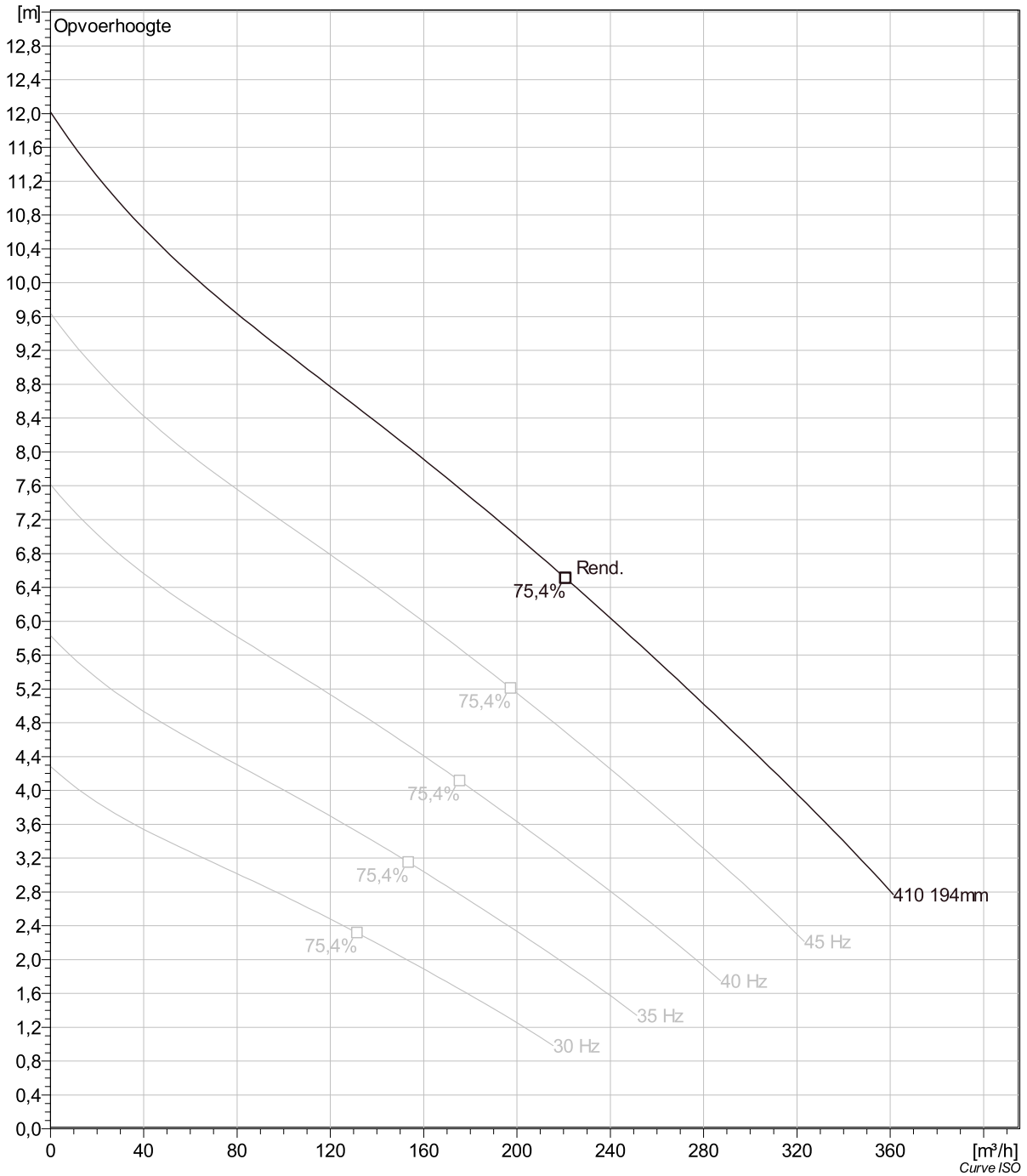

Project	Project ID	Created by	Created on	Last update
			9/28/2018	

CP 3127 LT 3~ 410 Dimensional drawing

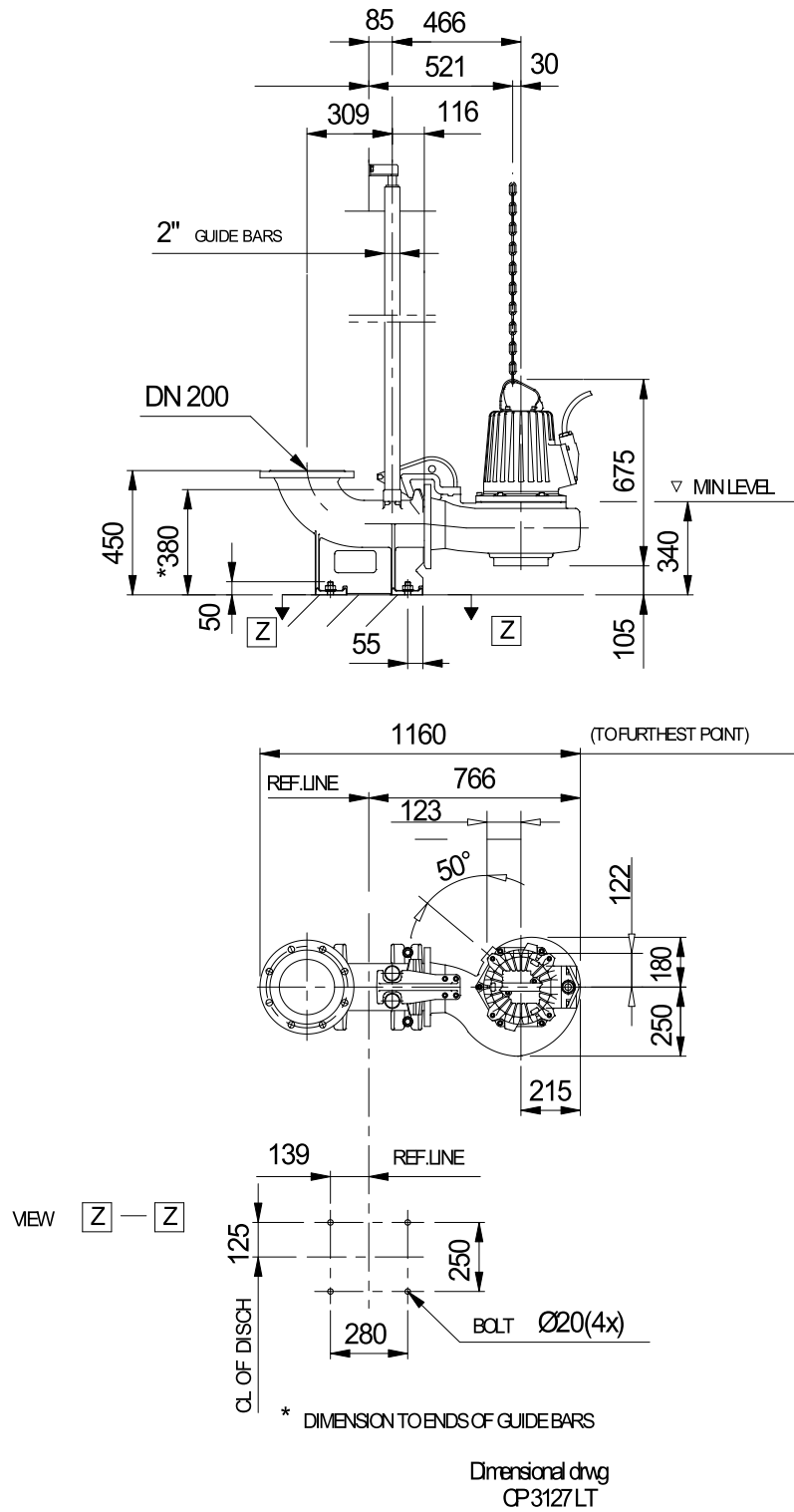

Project	Project ID	Created by	Created on	Last update
			9/28/2018	