

NP 3171 MT 3~ 434 Technische specificaties

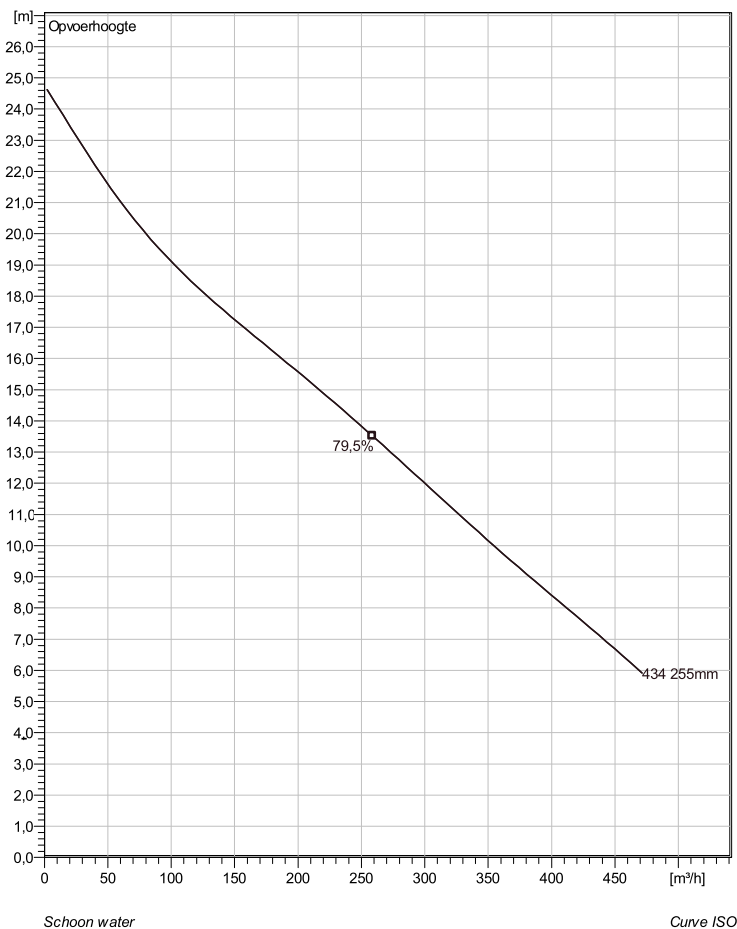

Note: Picture might not correspond to the current configuration.

General

Dompelbare pompen voorzien van verstopponsgevoelige N-waaiers. Geschikt voor afvalwater met grotere delen zoals rioolwater, regenwater en industriële afvalwater. Materiaal gietijzer.

Impeller

Impeller material	Grey cast iron
Persaansluiting	150 mm
Diameter aanzuigzijde	150 mm
Impeller diameter	255 mm
Aantal bladen	2

Motor

Motor #	N3171.181 25-14-4AA-W 15KW standaard
Stator variant	2
Frequentie	50 Hz
Nominale spanning	400 V
Aantal polen	4
Fasen	3~
Nominaal vermogen	15 kW
Toegekende stroom	31 A
Aanloopstroom	189 A
Nominaal toerental	1460 rpm
Vermogensfactor	
1/1 Load	0,81
3/4 Load	0,74
1/2 Load	0,62
Motor efficiency	
1/1 Load	87,0 %
3/4 Load	88,0 %
1/2 Load	87,5 %

Soort installatie: Semi Permanent, Nat

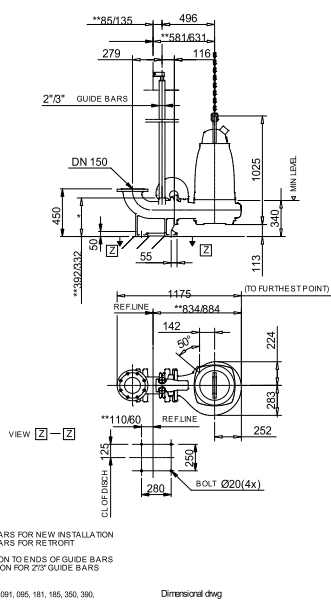

Project omschrijving	Projectnummer	Aangemaakt door:	Aangemaakt op 9/27/2018	Laatste wijziging
----------------------	---------------	------------------	----------------------------	-------------------

NP 3171 MT 3~ 434

Karakteristiek

Pomp

Persaansluiting	150 mm
Diameter aanzuigzijde	150 mm
Impeller diameter	255 mm
Aantal bladen	2

Motor

Motor #	N3171.181 25-14-4AA-W 15KW
Stator variant	2
Frequentie	50 Hz
Nominale spanning	400 V
Aantal polen	4
Fasen	3~
Nominaal vermogen	15 kW
Toegekende stroom	31 A
Aanloopstroom	189 A
Nominaal toerental	1460 rpm

Vermogensfactor	
1/1 Load	0,81
3/4 Load	0,74
1/2 Load	0,62
Motor efficiency	
1/1 Load	87,0 %
3/4 Load	88,0 %
1/2 Load	87,5 %

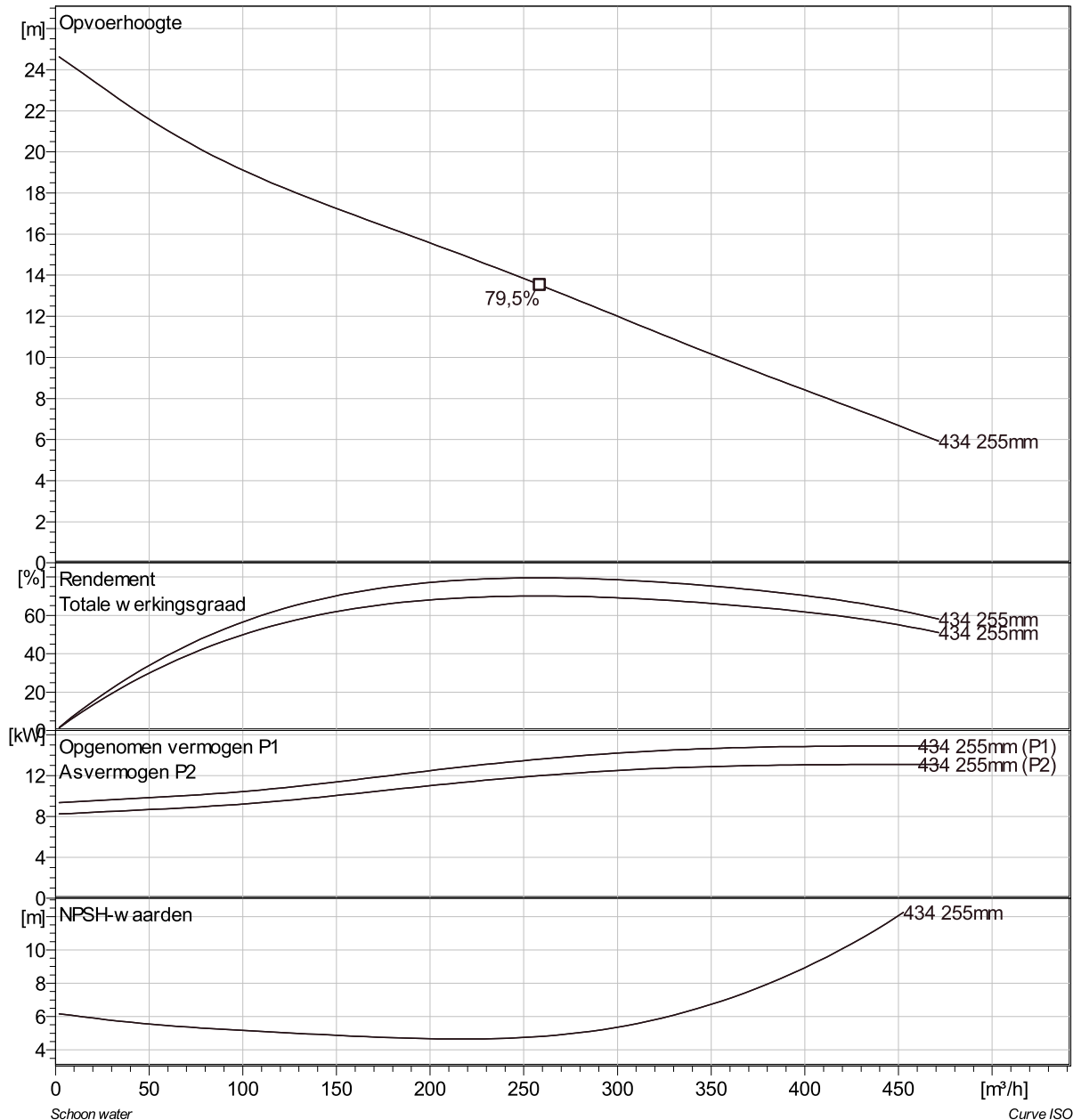

Project omschrijving	Projectnummer	Aangemaakt door:	Aangemaakt op 9/27/2018	Laatste wijziging
----------------------	---------------	------------------	----------------------------	-------------------

NP 3171 MT 3~ 434

VFD Analysis

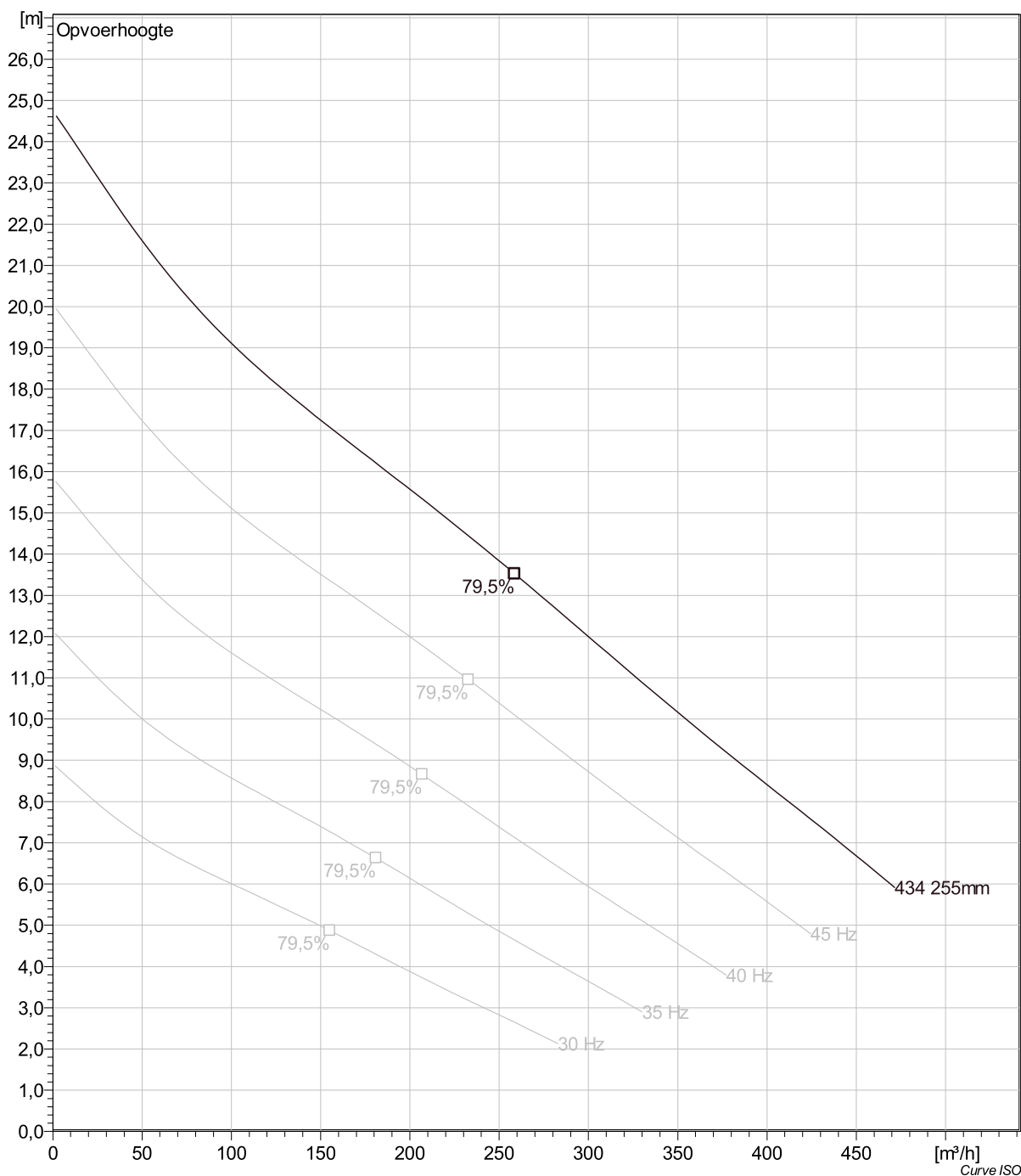

Project omschrijving	Projectnummer	Aangemaakt door:	Aangemaakt op 9/27/2018	Laatste wijziging
----------------------	---------------	------------------	----------------------------	-------------------

NP 3171 MT 3~ 434 Dimensional drawing

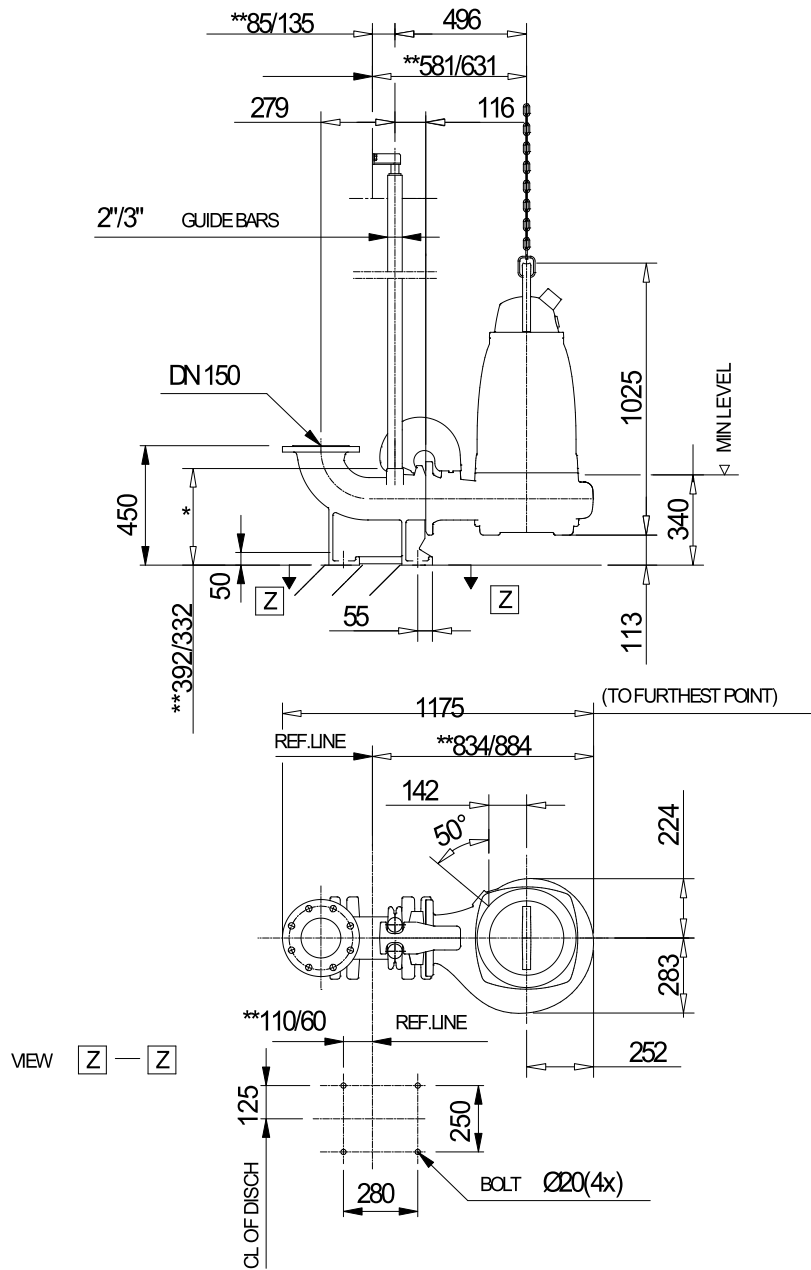

2' GUIDE BARS FOR NEW INSTALLATION
3' GUIDE BARS FOR RETROFIT

* DIMENSION TO ENDS OF GUIDE BARS
** DIMENSION FOR 2'/3' GUIDE BARS

NP,FP 3171.091, 095, 181, 185, 350, 390, 660, 670
MT

Dimensional drwg

NP,FP 3171.091,095,181,185,350,390,660,670 MT

Project omschrijving	Projectnummer	Aangemaakt door:	Aangemaakt op 9/27/2018	Laatste wijziging
----------------------	---------------	------------------	----------------------------	-------------------