

NS 3202 SH 3~ 273 Technische specificaties

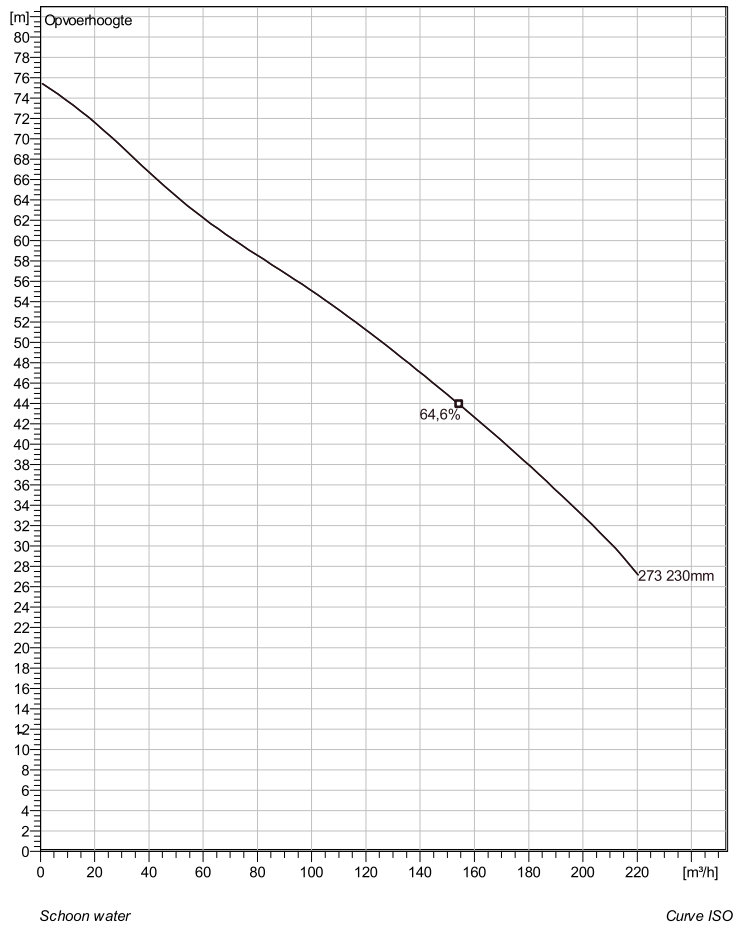

Note: Picture might not correspond to the current configuration.

General

Dompelbare pompen voorzien van een verstoppingsongevoeilige N-waaiër. Geschikt voor afvalwater met grotere delen zoals rioolwater, regenwater en industriële afvalwater. Materiaal gietijzer.

Impeller

Impeller materiaal	Hard-Iron
Persaansluiting	100 mm
Diameter aanzuigzijde	150 mm
Impeller diameter	230 mm
Aantal bladen	2

Motor

Motor #	N3202.185 30-19-2AA-W 32KW standaard
Stator variant	38
Frequentie	50 Hz
Nominale spanning	380 V
Aantal polen	2
Fasen	3~
Nominaal vermogen	32 kW
Toegekende stroom	58 A
Aanloopstroom	405 A
Nominaal toerental	2950 rpm
Vermogensfactor	
1/1 Load	0,93
3/4 Load	0,92
1/2 Load	0,88
Motor efficiency	
1/1 Load	90,1 %
3/4 Load	90,6 %
1/2 Load	90,0 %

Soort installatie: Semi permanent, Nat

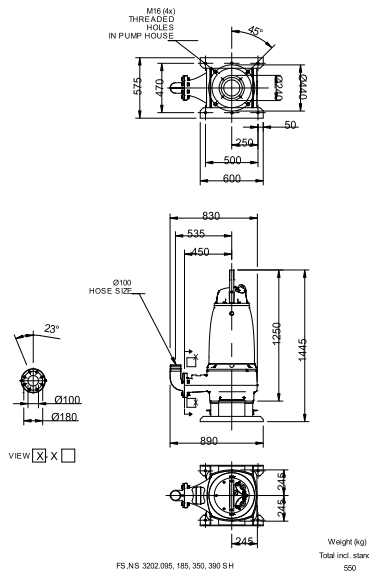

Project	Project ID	Created by	Created on 10/5/2018	Last update
---------	------------	------------	-------------------------	-------------

NS 3202 SH 3~ 273

Karakteristiek

Pomp

Persaansluiting	100 mm
Diameter aanzuigzijde	150 mm
Impeller diameter	230 mm
Aantal bladen	2

Motor

Motor #	N3202.185 30-19-2AA-W 32KW
Stator variant	38
Frequentie	50 Hz
Nominale spanning	380 V
Aantal polen	2
Fasen	3~
Nominaal vermogen	32 kW
Toegekende stroom	58 A
Aanloopstroom	405 A
Nominaal toerental	2950 rpm

Vermogensfactor	
1/1 Load	0,93
3/4 Load	0,92
1/2 Load	0,88
Motor efficiency	
1/1 Load	90,1 %
3/4 Load	90,6 %
1/2 Load	90,0 %

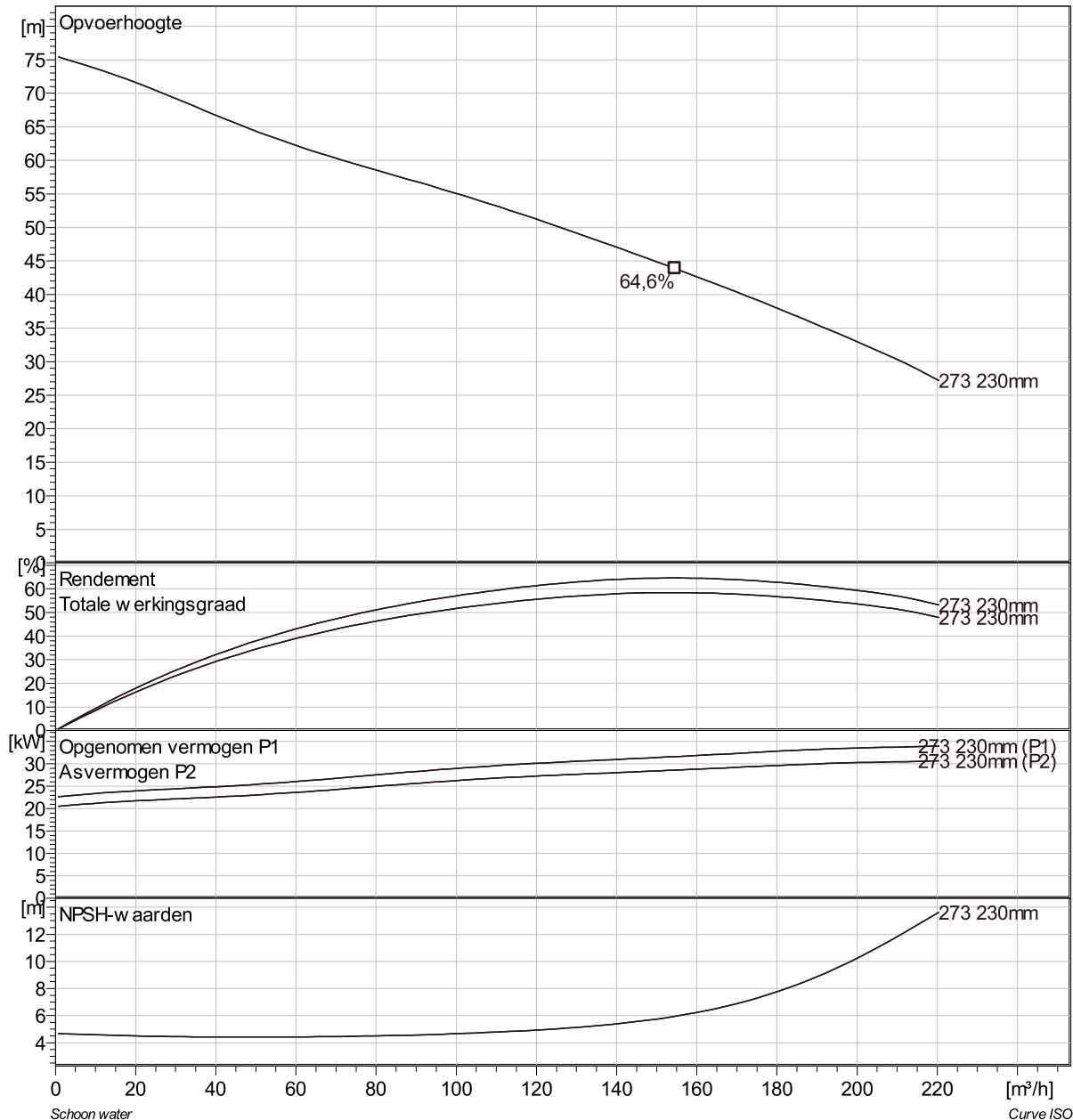

Project	Project ID	Created by	Created on 10/5/2018	Last update
---------	------------	------------	-------------------------	-------------

NS 3202 SH 3~ 273 VFD Analysis

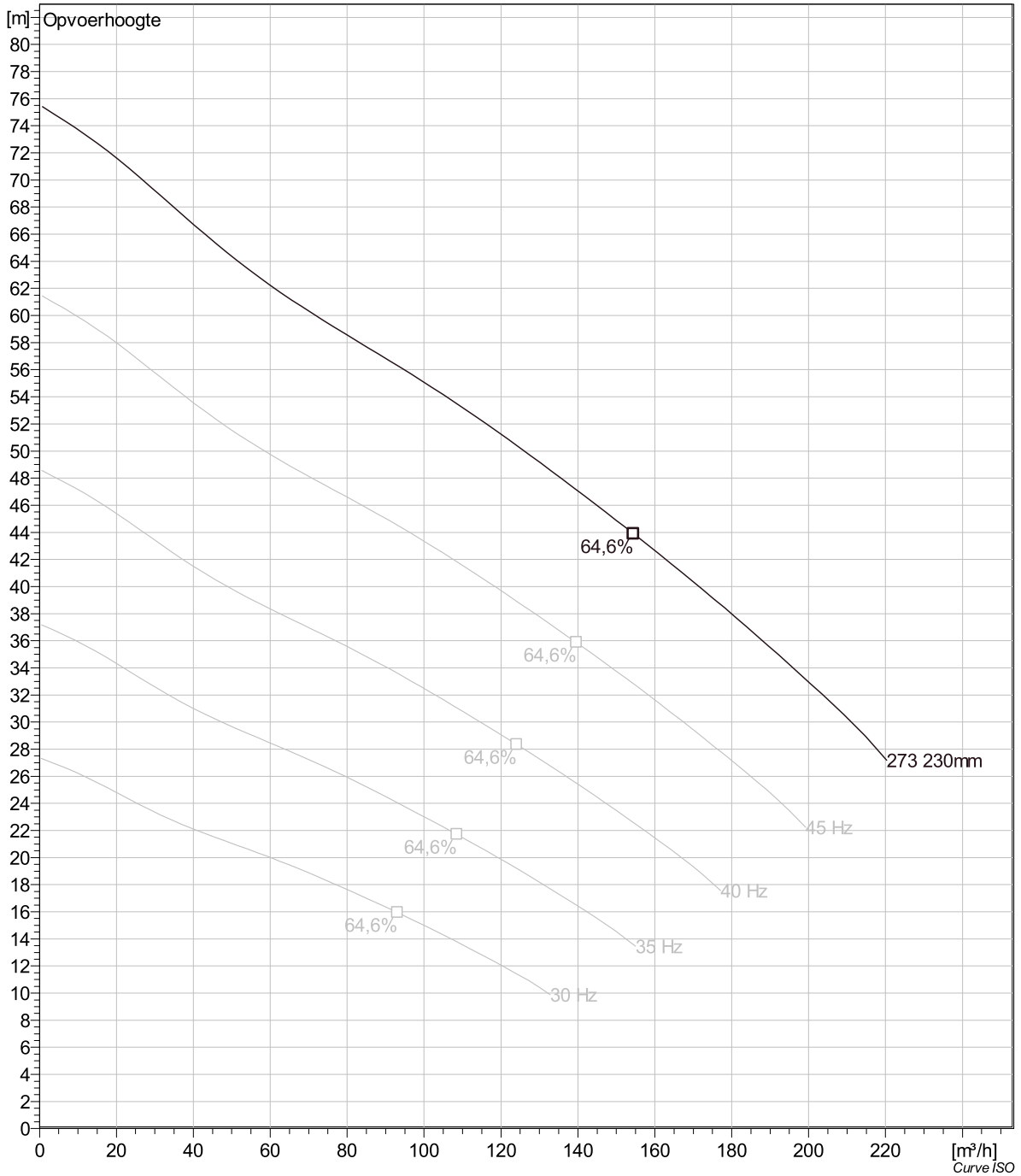

Project	Project ID	Created by	Created on	Last update
			10/5/2018	

NS 3202 SH 3~ 273 Dimensional drawing

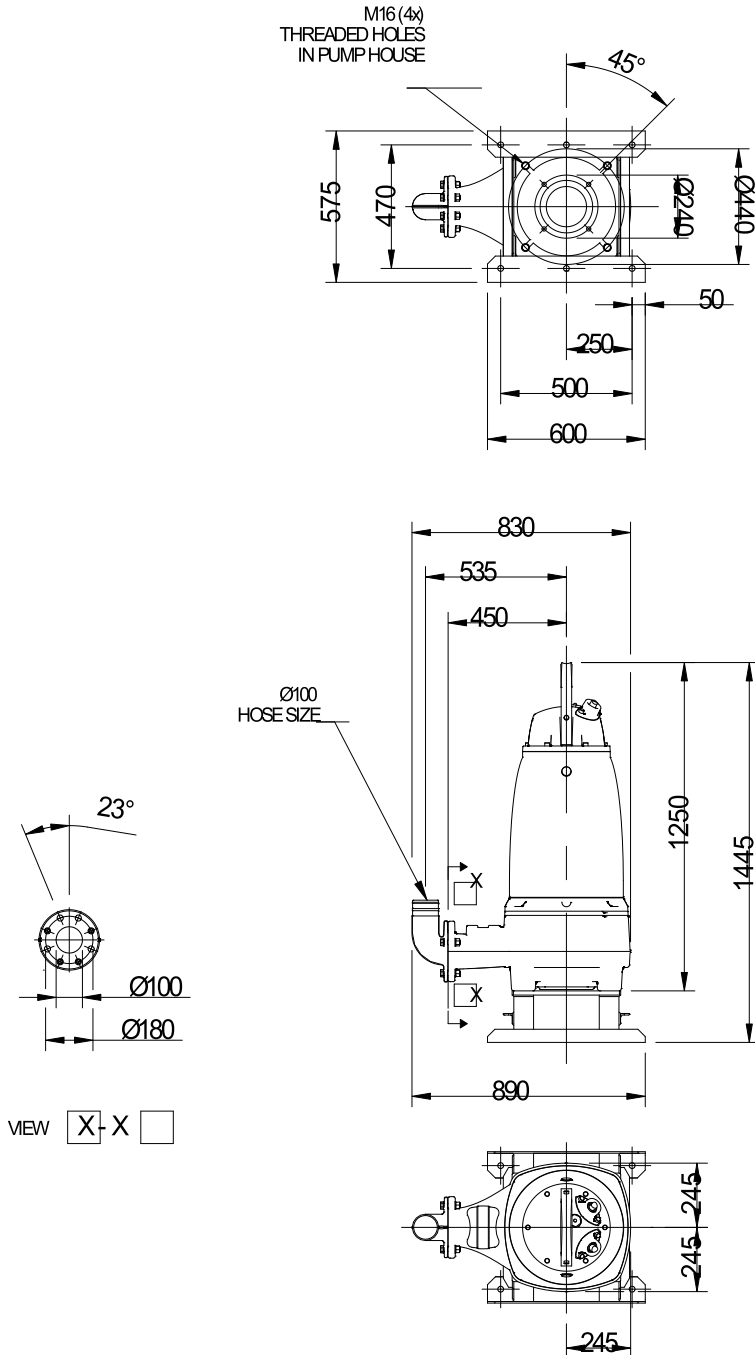

FS,NS 3202.095, 185, 350, 390 SH

Weight (kg)
Total incl. stand
550

FSNS3202.095,185,350,390 SH

Project	Project ID	Created by	Created on	Last update
			10/5/2018	