

NS 3315 HT 3~ 455 Technische specificaties

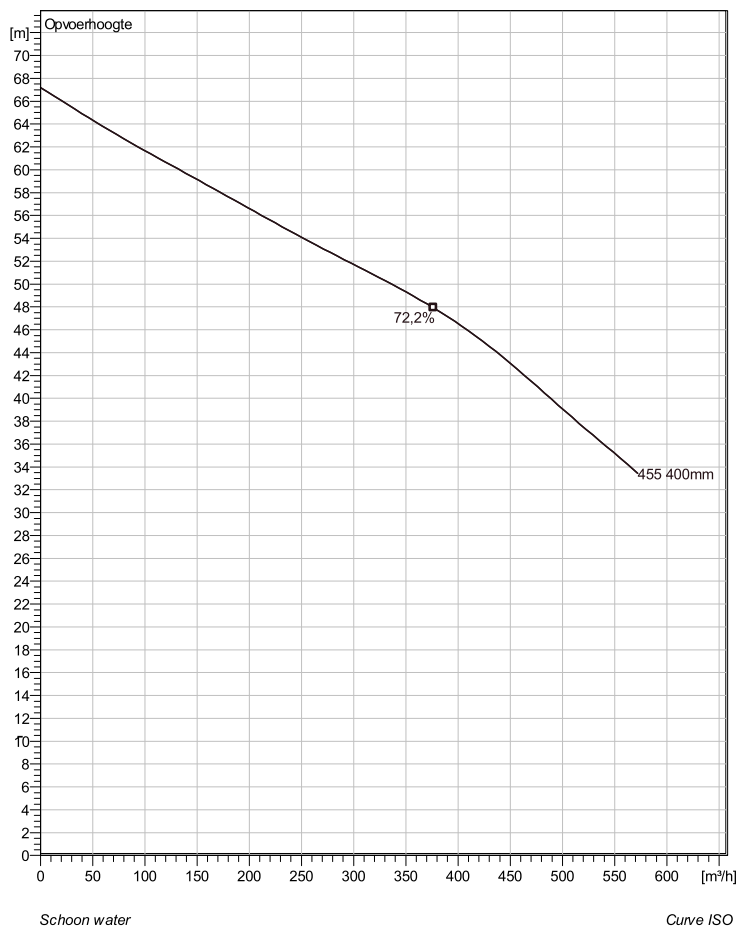

Note: Picture might not correspond to the current configuration.

General

Dompelbare pompen voorzien van een verstoppingsongevoeilige N-waaiër. Geschikt voor afvalwater met grotere delen zoals rioolwater, regenwater en industriële afvalwater. Materiaal gietijzer.

Impeller

Impeller material	Grey cast iron
Persaansluiting	150 mm
Diameter aanzuigzijde	150 mm
Impeller diameter	400 mm
Aantal bladen	3

Motor

Motor #	N3315.180 35-45-4AA-W 105KW standaard
Stator variant	1
Frequentie	50 Hz
Nominale spanning	380 V
Aantal polen	4
Fasen	3~
Nominaal vermogen	105 kW
Toegekende stroom	201 A
Aanloopstroom	1040 A
Nominaal toerental	1475 rpm
Vermogensfactor	
1/1 Load	0,85
3/4 Load	0,81
1/2 Load	0,72
Motor efficiency	
1/1 Load	93,8 %
3/4 Load	94,8 %
1/2 Load	95,3 %

Soort installatie: Semi permanent, Nat

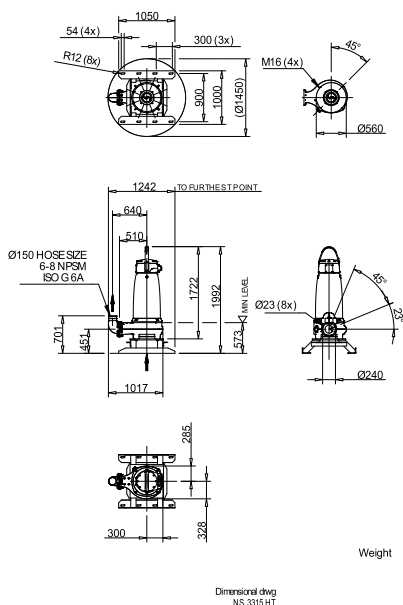

Weight

Project	Project ID	Created by	Created on 10/5/2018	Last update
---------	------------	------------	-------------------------	-------------

NS 3315 HT 3~ 455

Karakteristiek

Pomp

Persaansluiting	150 mm
Diameter aanzuigzijde	150 mm
Impeller diameter	400 mm
Aantal bladen	3

Motor

Motor #	N3315.180 35-45-4AA-W 105KW
Stator variant	1
Frequentie	50 Hz
Nominale spanning	380 V
Aantal polen	4
Fasen	3~
Nominaal vermogen	105 kW
Toegekende stroom	201 A
Aanloopstroom	1040 A
Nominaal toerental	1475 rpm

Vermogensfactor	
1/1 Load	0,85
3/4 Load	0,81
1/2 Load	0,72
Motor efficiency	
1/1 Load	93,8 %
3/4 Load	94,8 %
1/2 Load	95,3 %

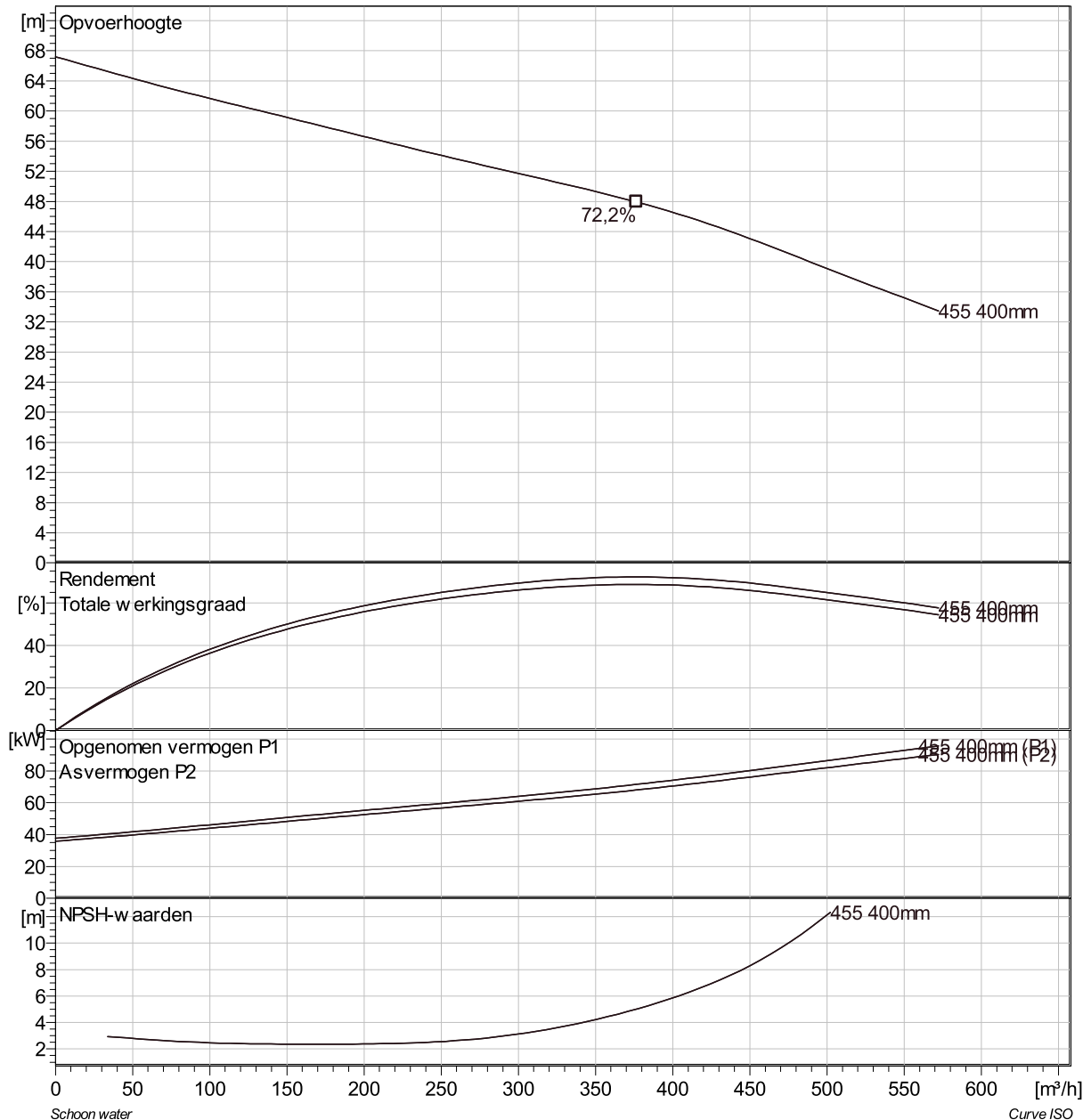

Project	Project ID	Created by	Created on 10/5/2018	Last update
---------	------------	------------	-------------------------	-------------

NS 3315 HT 3~ 455 VFD Analysis

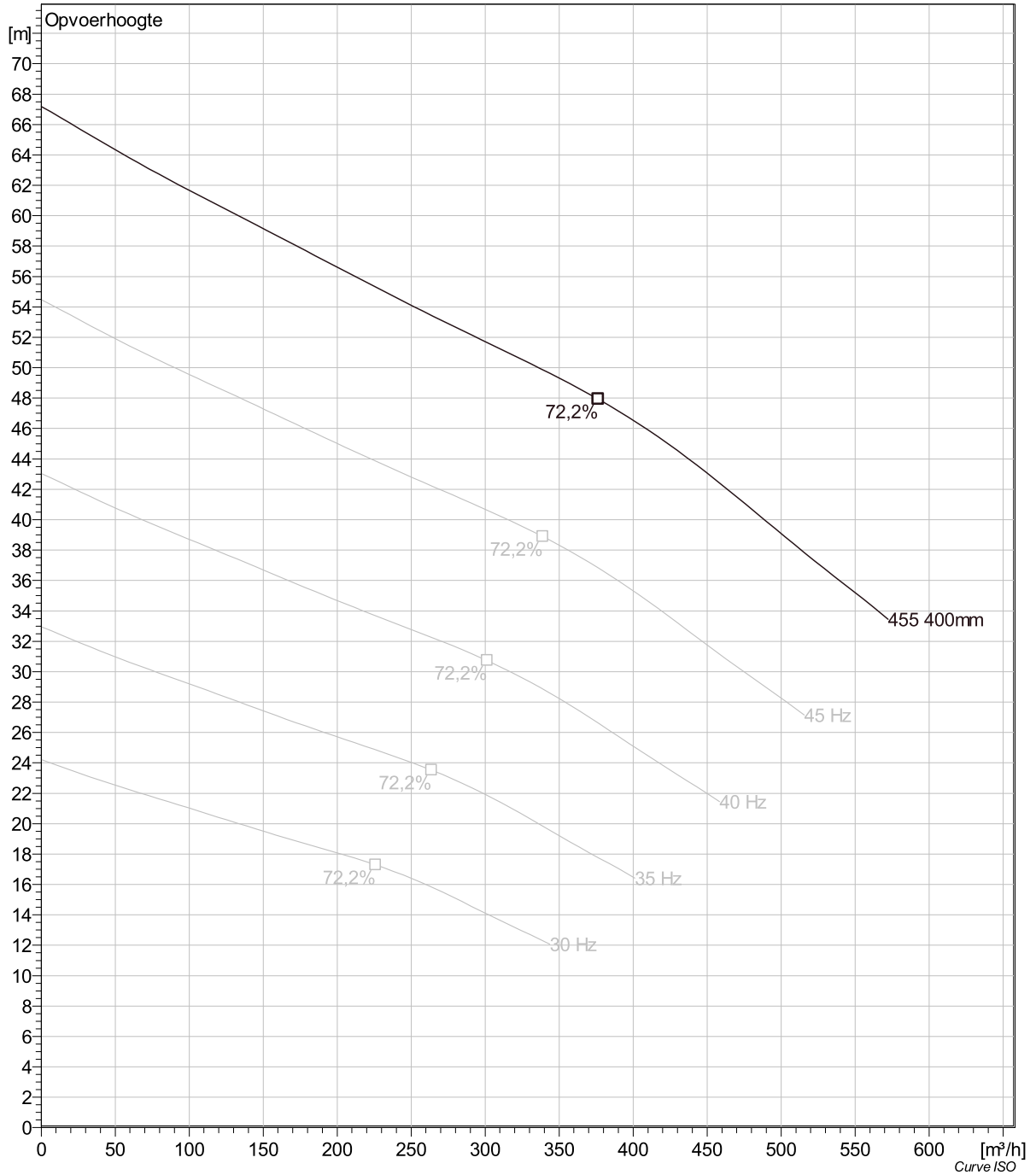

Project	Project ID	Created by	Created on	Last update
			10/5/2018	

NS 3315 HT 3~ 455 Dimensional drawing

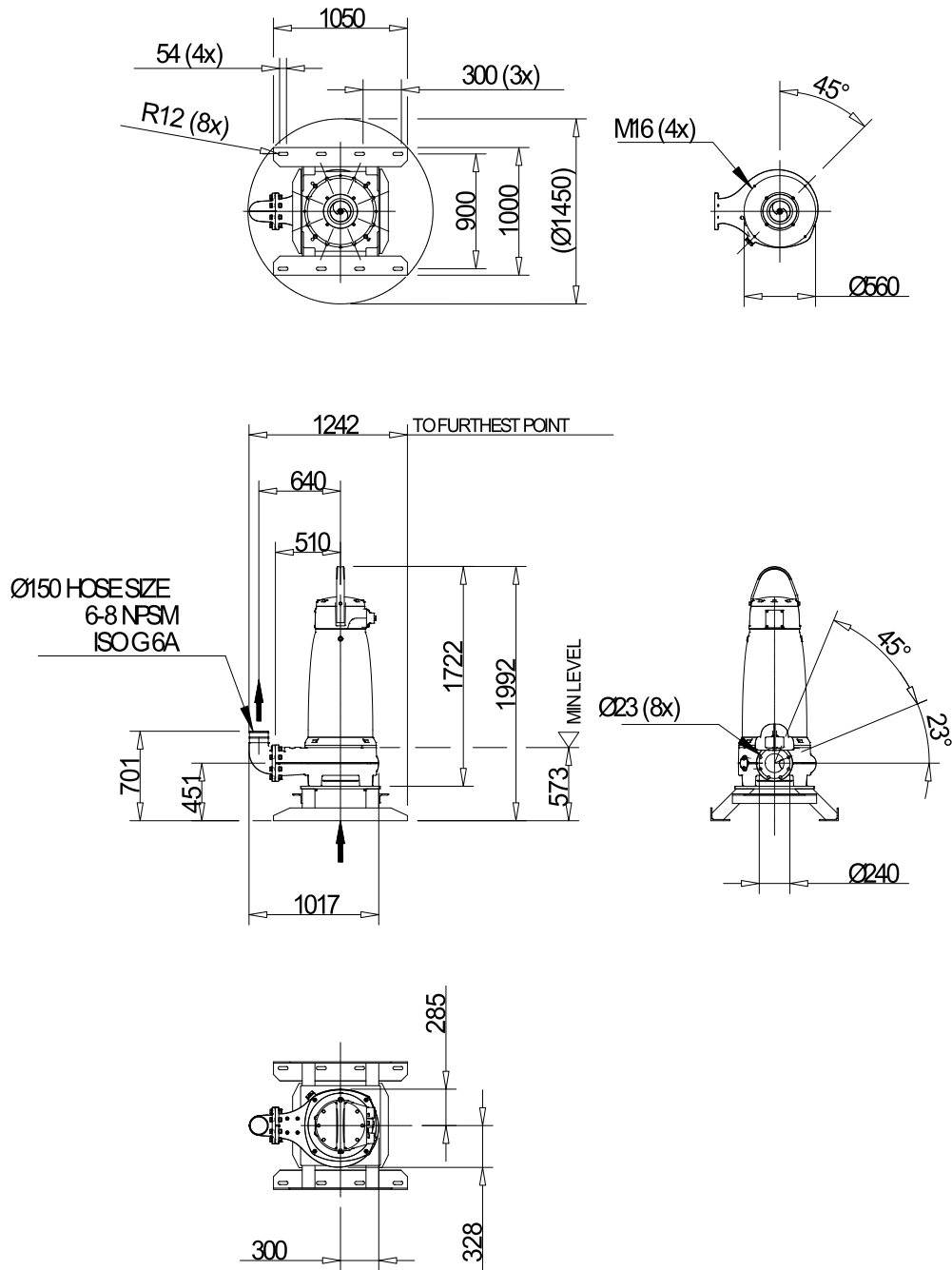

Weight

Dimensional drwg
NS 3315 HT

Project	Project ID	Created by	Created on	Last update
			10/5/2018	