

Pump type: Submersible vortex pump
 Application: Waste water, sewage

Pump data

Solids passage 65 mm
 Discharge/ Suction diameter 67mm/ 72 mm
 Impeller type: Vortex
 Impeller diameter 178 - 150 mm
 Recommended min. flow 2 l/sec (8 m3/h)
 Weight 120 kg

Motor

Mains: 50 c/s – 3 phase
 Rated shaft power 13.0 kW
 Rated electrical power 14.5 kW
 Nominal speed 2915 rpm
 Motor efficiency 90 %
 Power factor (cos phi) 0.87
 Degree of protection IP 68
 Isolation class F (155°C)
 Max. water temperature 40°C
 Standard cable length 10 m

Materials

Pump casing Cast iron GG 25 (EN-GJL-250)
 Impeller S.g cast iron GGG 40 (EN-GJS-400-15)
 Motor unit Cast iron GG 25 (EN-GJL-250)
 Shaft AISI 431
 Alt: AISI 316
 Bolts AISI 316
 Elastomers Nitrile (NBR) or neoprene (CR)
 Alt: viton (FPM)
 Electrical cable Neoprene (CR)
 Seal lubrication Oil
 Seal pump side Silicon carbide – silicon carbide
 Seal motor side Carbon - Ceramic
 Coating Two components polyurethane

Installation options

Header coupling BWK 080



Guide bar coupling OWK 080



Freestanding Including support (VRS) 75 mm hose connection or G 3" threaded connection



Optional

- Flameproof version, to class: II 2 G Ex d IIB c T4
 Standard: II 2 G Ex b c d IIB T4 Gb
 With Frequency control: II 2 G Ex b c d IIB T3 Gb
- Thermo switches in stator windings (standard for flame proof version)
- Cable protective sheathing (AISI 316)
- Water detector in motor and oil chamber
 Flameproof version with external cable

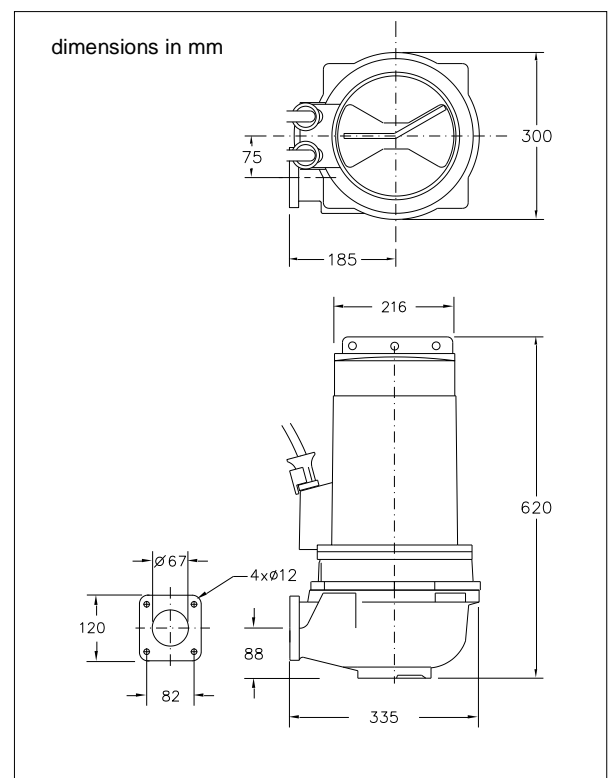
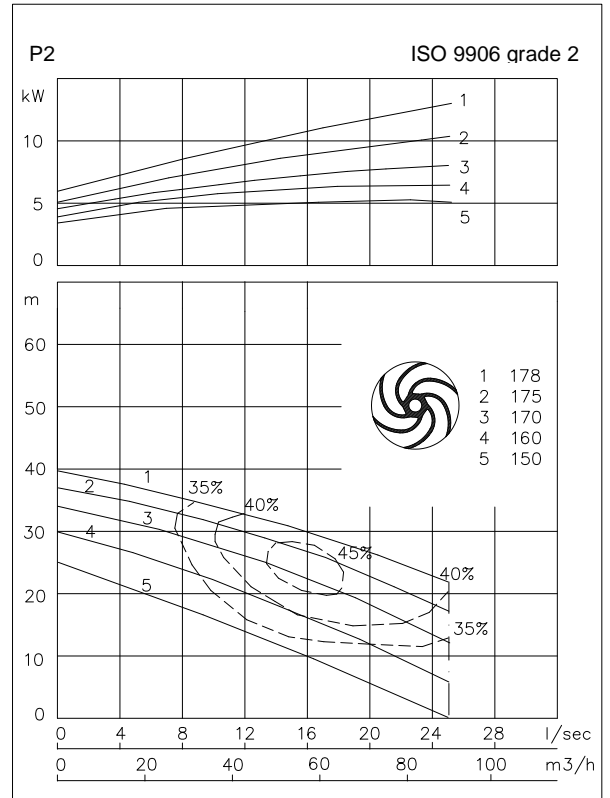

Connections

voltage [V]*	current [A]	Electrical cable size [mm2]		motor protection and/or water detector		flameproof version		
		direct start	stardelta start	direct start	stardelta start	direct start	stardelta start	
230	42.1	4G10	2x4G6	4G10 + 4G1.5	-	4G10 + 4G2.5	-	
400	24.2	4G6	7G1.5	4G6 + 4G1.5	12G1.5	4G6 + 4G2.5	12G1.5	
500	19.3	4G2.5	7G1.5	7G2.5	12G1.5	7G2.5	12G1.5	
starting current DOL start : 7.8 x rated current								
starting current YD start : 2.6 x rated current								
							* other voltages on request	